

# FORATURA PIANO

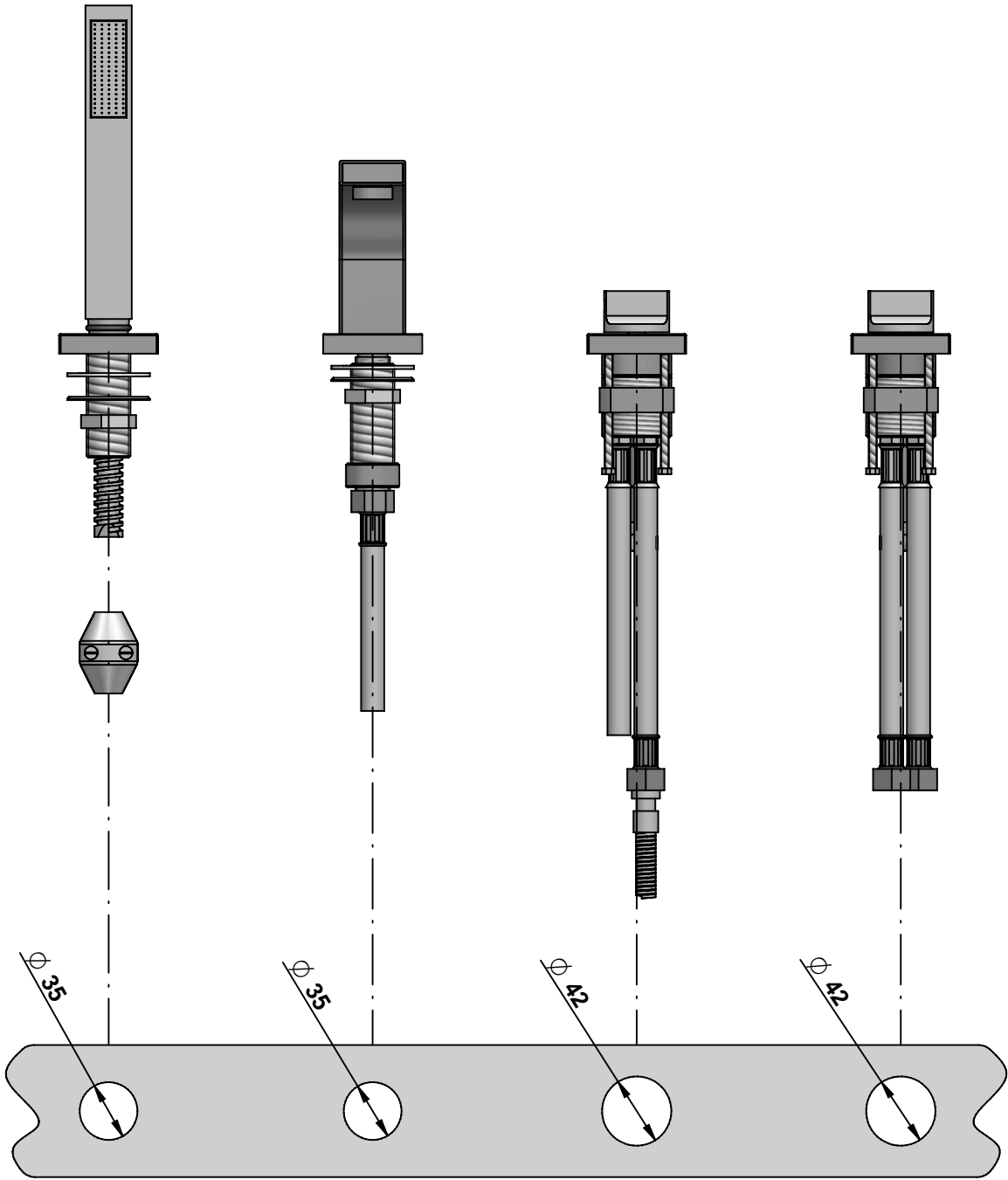

# INSTALLAZIONE

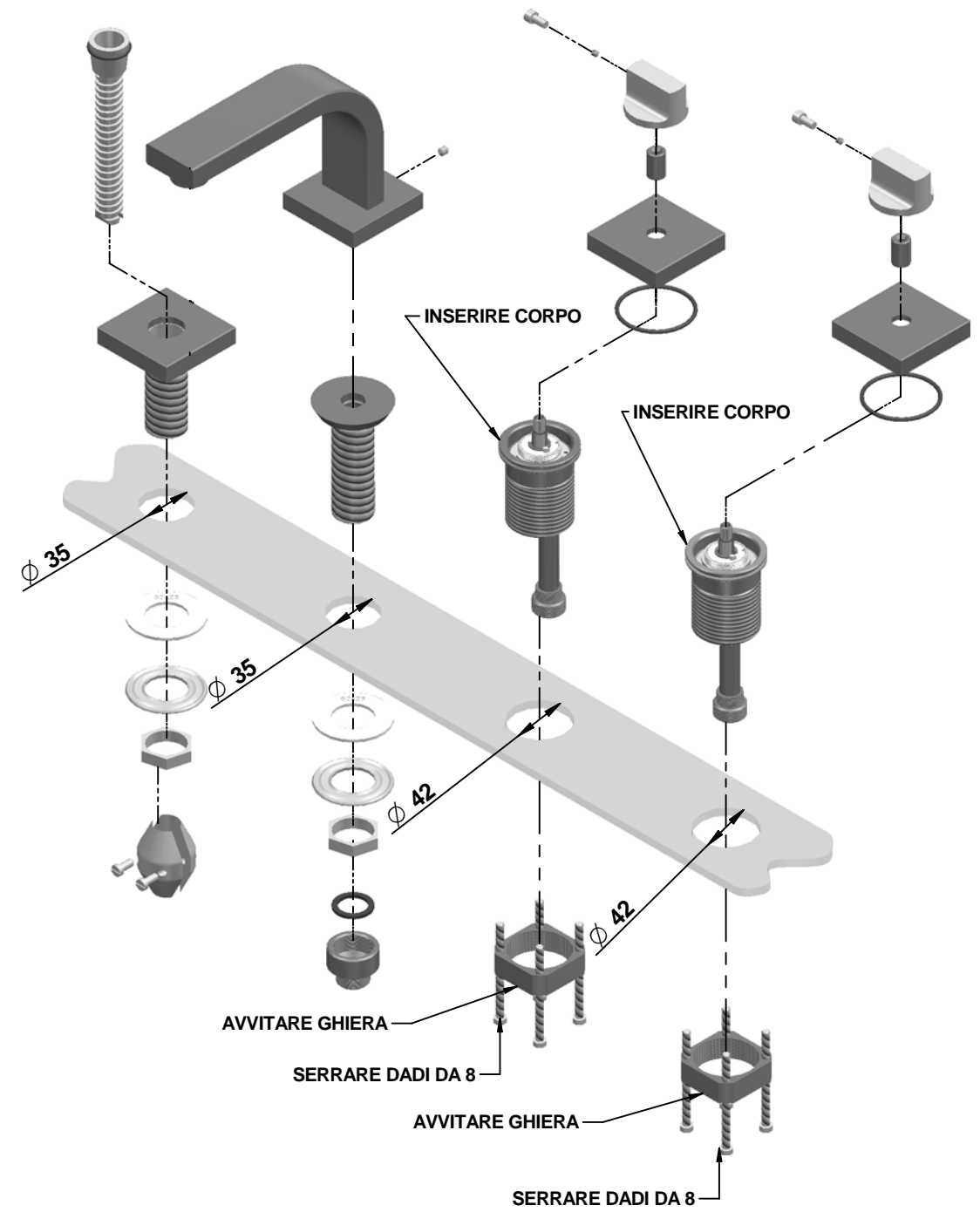
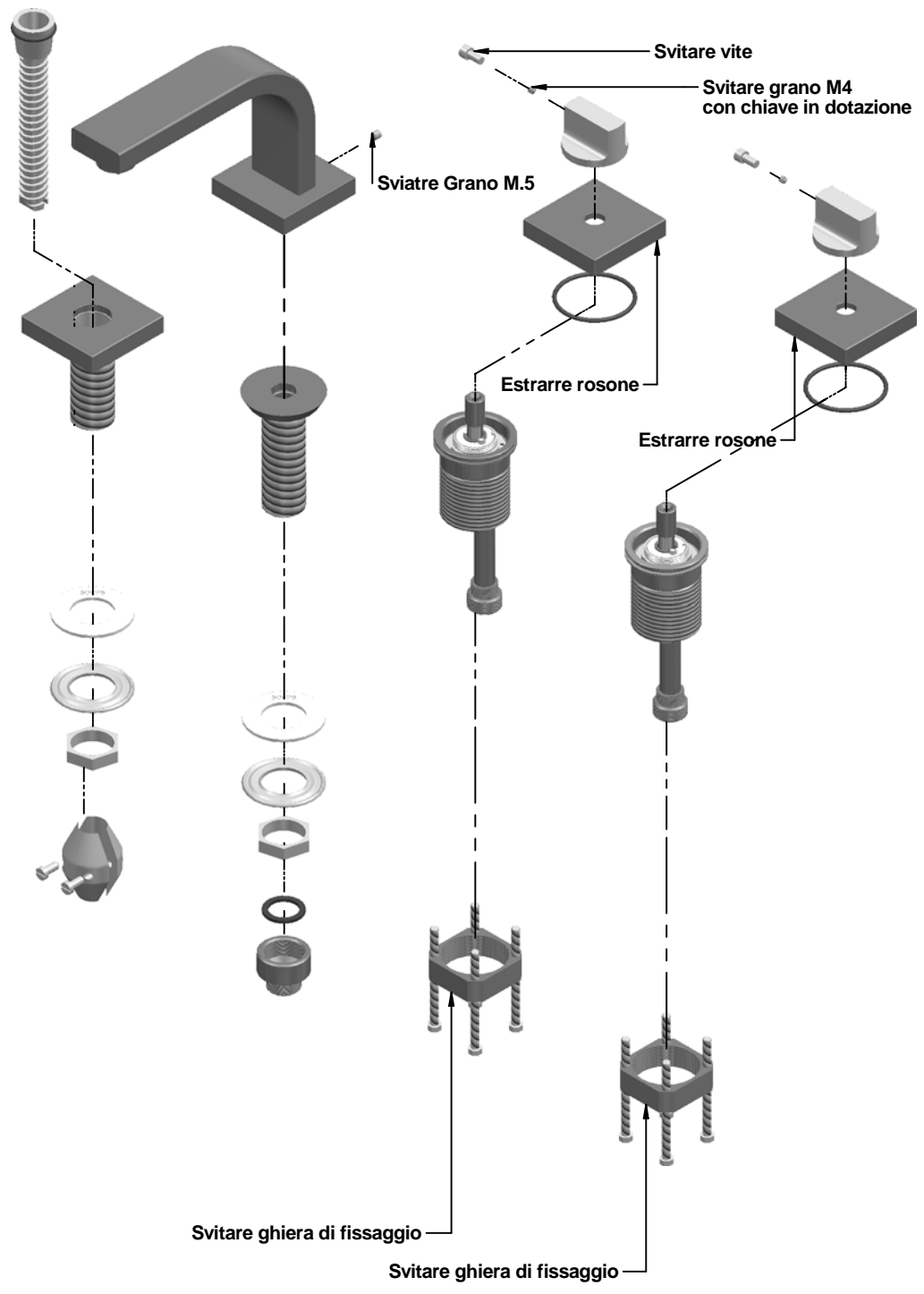

# INSTALLAZIONE

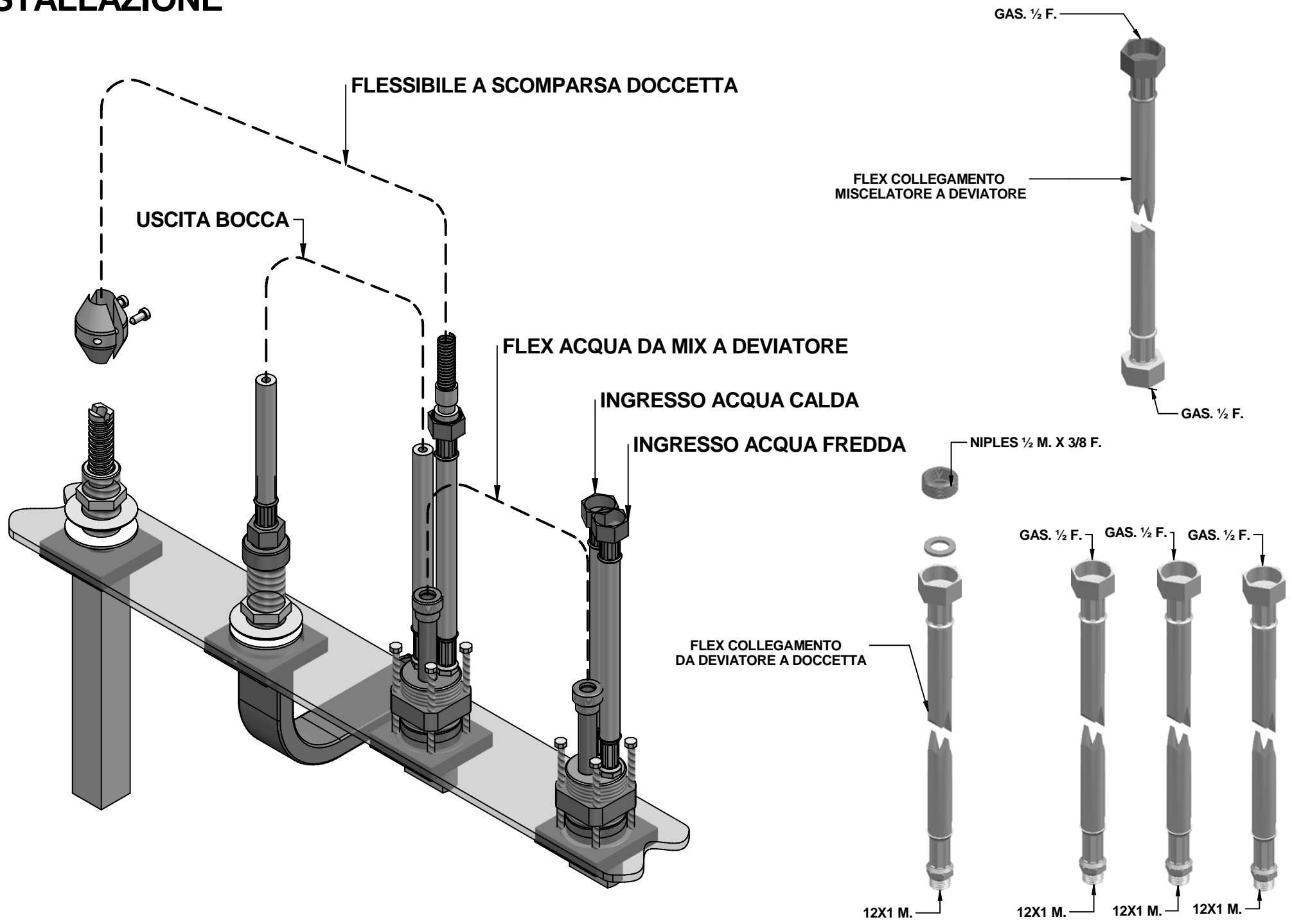

# SOSTITUZIONE CARTUCCE

## DETTAGLIO A

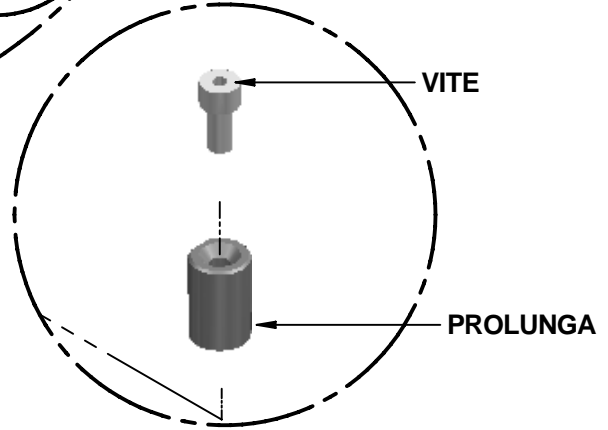
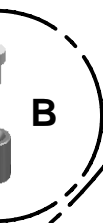
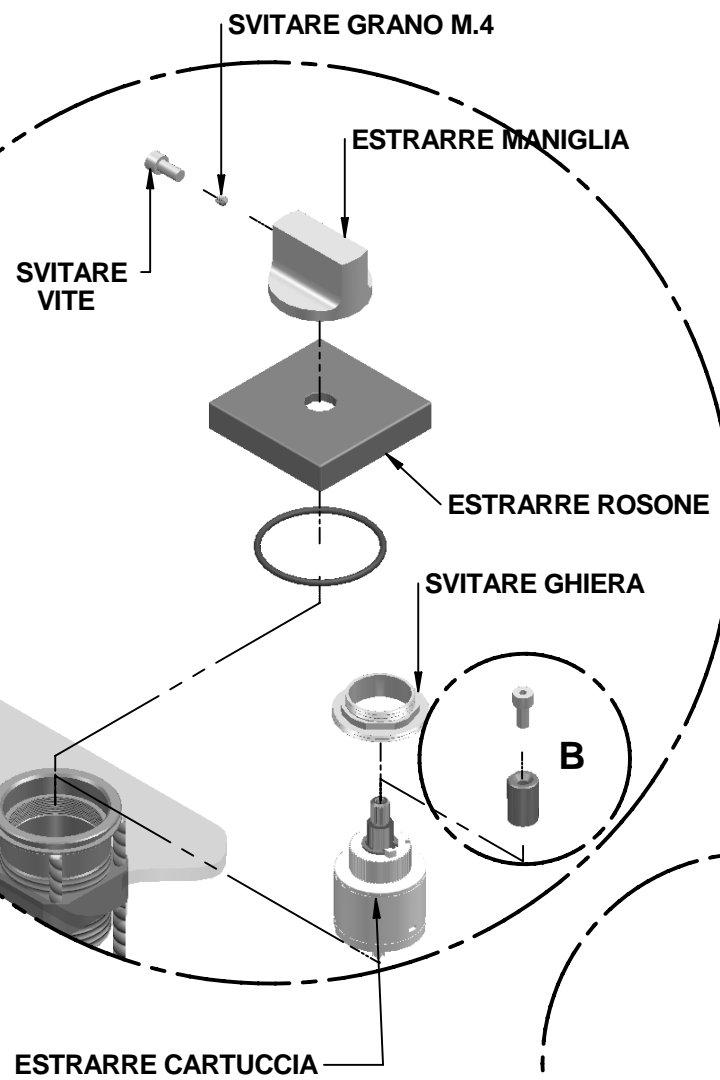

CHIAVE DINAMOMETRICA CON BUSSOLA ES. 28  
CHIAVE A TUBO DA ES. 28

