

Corpo incasso
Built in body

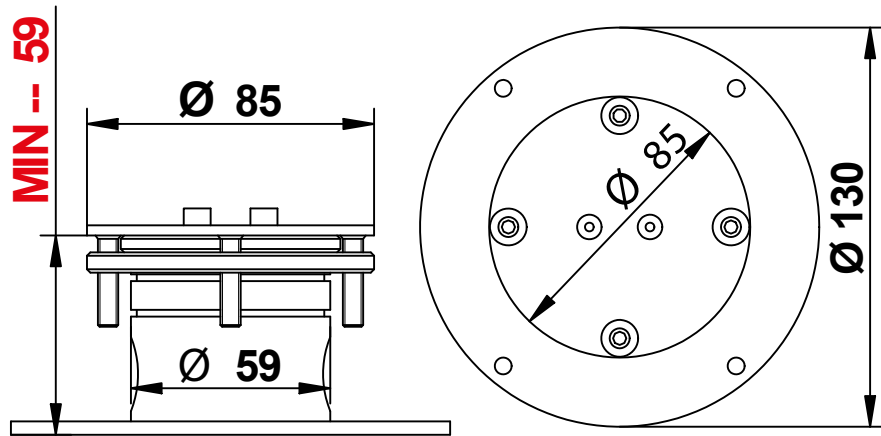

A Fare attenzione che il corpo incasso sia perfettamente bloccato tramite tasselli posti sulla staffa e cemento.

Keep attention also the body is absolutely well locked utilizing the screws of the plate and the cement.

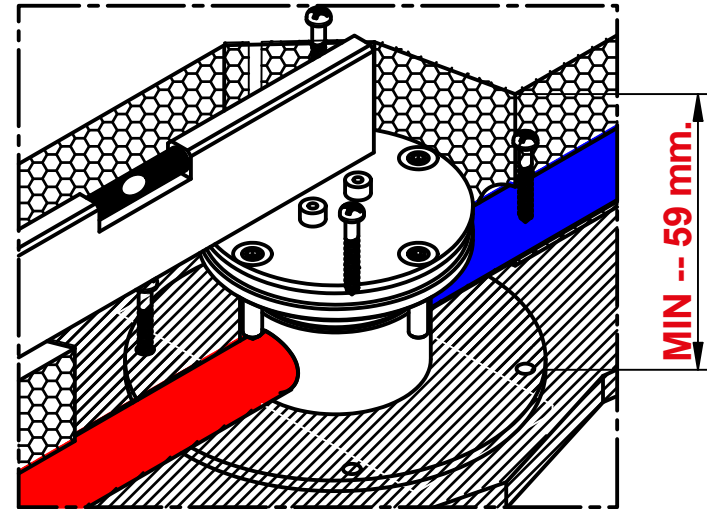

B

Foro piastrelle
MIN 86mm. -- MAX 90mm.

Size tiles hole
Min 86mms. -- MAX 90mms.

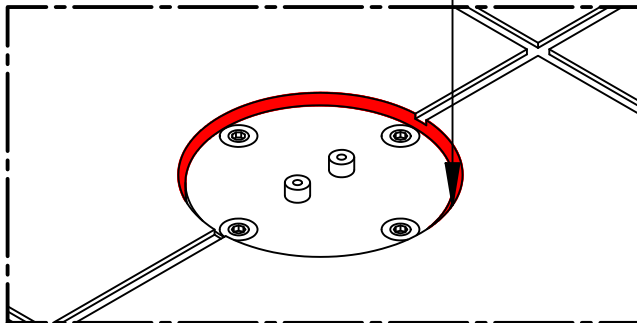

C

Rimuovere protezione.

Remove the protection.

Tenere le viti di fissaggio.

Keep the screws to fix the column.

